

Description

IRE is a range of insulated in-line centrifugal duct fans. They provide high pressure with low sound level. The IRE fans have good sound and fire insulation qualities provided by a 50mm pad of mineral wool. The high quality ball bearing mounted external rotor motors are maintenance free. They can be speed controlled from 0-100% by voltage variation. All motors are protected by approved thermo contacts. All 3-phase motors have ready fitted thermo contact leads for alarm functions etc. The fans have a strong galvanized steel housing incorporating a swing out design of the fan motor and impeller for easy cleaning and inspection.



Technical data

Parameter	Value	Unit
Voltage	400	V
Phase	3	~
Frequency	50	Hz
Power	1.2	kW
Current	2.8	A
R.p.m.	660	r/m
Max. temperature of transported air	60	°C
Max. temperature of transported air when speed-controlled	60	°C
Sound pressure level at 3 m	45	dB(A)
Length	990	mm
Width	952	mm
Height	705	mm
Weight	86	kg
Enclosure class, motor	44	IP
Insulation class, motor	F	
Duct connection	ø630 mm	

Diagrams

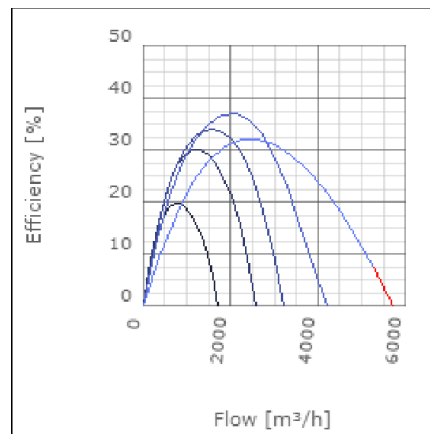
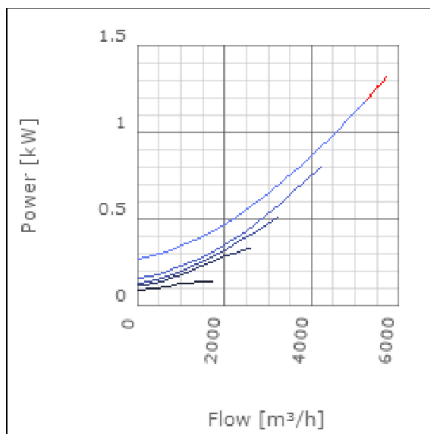
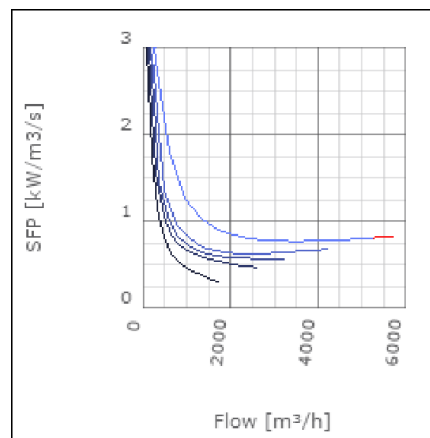
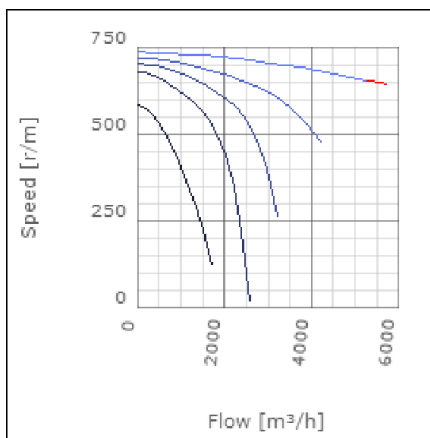
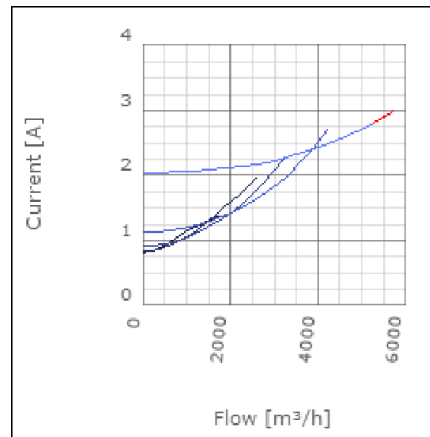
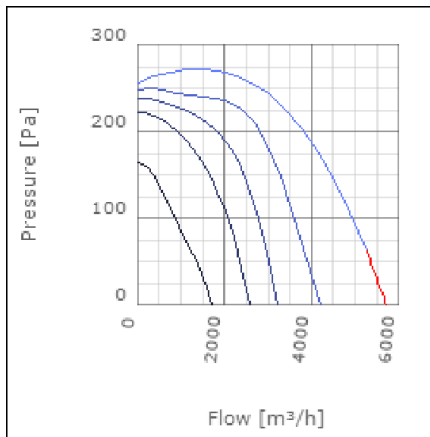

Sound

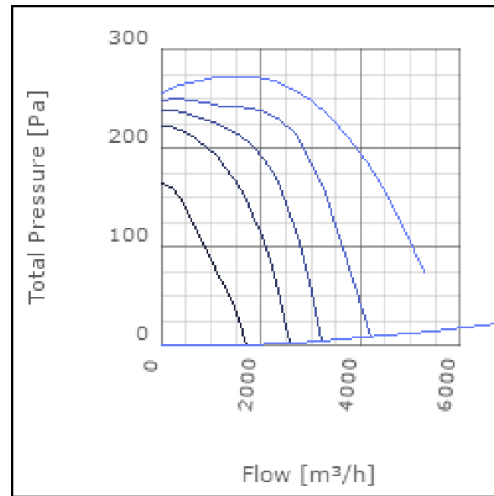
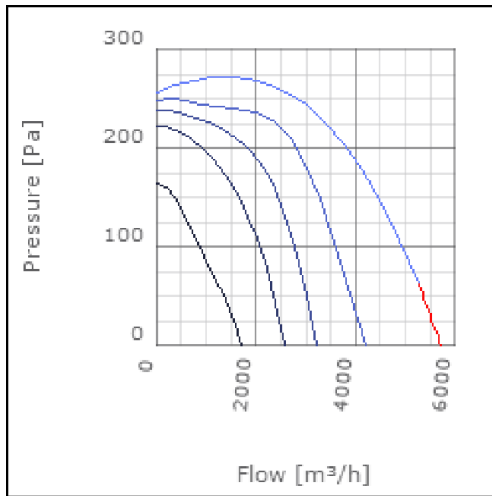

	Tot	63	125	250	500	1k	2k	4k	8k
Inlet	-	-	-	-	-	-	-	-	-
Outlet	-	-	-	-	-	-	-	-	-
Surrounding	-	-	-	-	-	-	-	-	-
Surrounding	-	-	-	-	-	-	-	-	-

120									
80									
40									
0									
	Tot	63	125	250	500	1k	2k	4k	8k

Parameter

Distance: 3.000
 Propagation type: Hemi-spherical
 Equivalent absorption area: 20.00

Dimensions

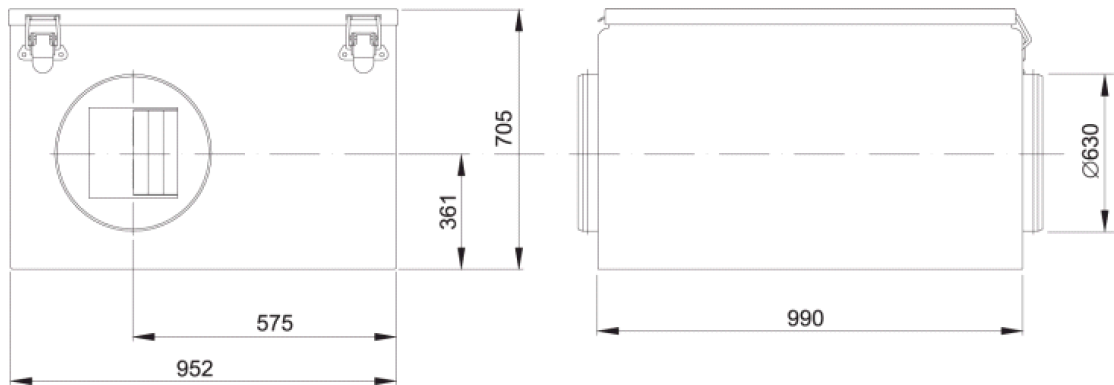

Wiring diagram

4040004

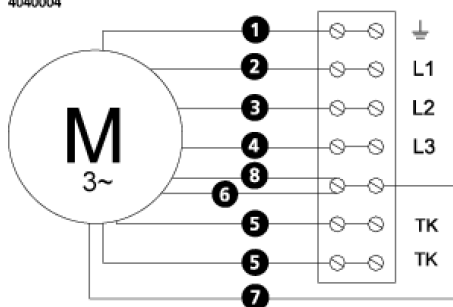

- (M) = Fan Motor
- (M1) = Fan Motor
- (M2) = Fan Motor
- (M3) = Rotor Motor
- 1 = Yellow/Green
- 2 = Black
- 3 = Blue
- 4 = Brown
- 5 = White (TW)
- 6 = Orange
- 7 = Grey
- 8 = Red
- 9 = Green
- 10 = Violet

Accessories

VRDT 4

VRTT 4

Electrical accessories

BSV 630